

Rated Voltage (Vac)	220
Rated Power (w)	400
Rated Torque (N.m)	1.27
Peak Torque (N.m)	3.81
Rated Speed (rpm)	3000
Peak Speed (rpm)	5000
Rated Current (Amp)	2.1
Peak Current (Amp)	6.5
Torque Const (N.m/Amp)	0.645
Back EMF Const (V/krpm)	39
Resistance (Ω)	5.7
Inductance (mH)	12
Inertia (kg*m ² *10 ⁻⁴)	0.56
Poles	10
Encoder type	23bit magnetic
IP rating	IP67
Mass (Kg)	1.3

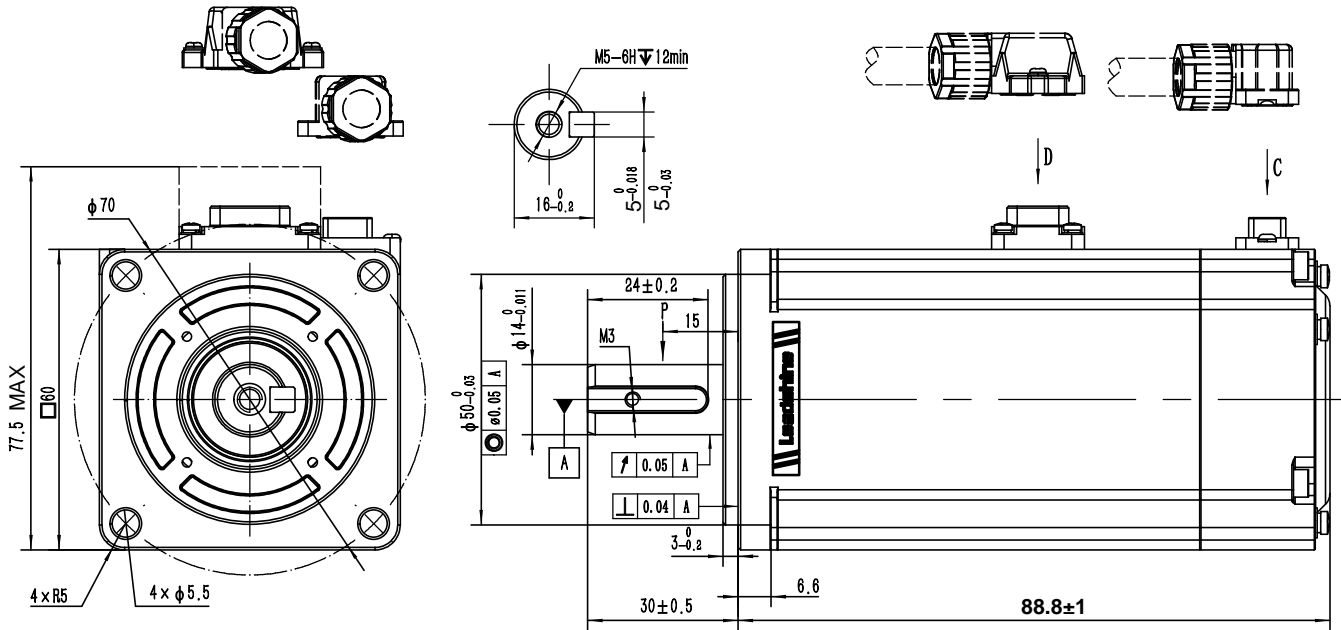

D

Wiring details of Power cable connector						
Pos	1	2	3	4	--	--
Signal	U	V	W	PE	--	--
Color	black	white	red	Yel/Gre	--	--

C

Wiring details of encoder cable connector							
Pos	1	2	3	4	5	6	7
Signal	PE	5V	0V	SD+	SD-	Bat+	Bat-
Color	shield	red	black	blue	yellow	brown	white

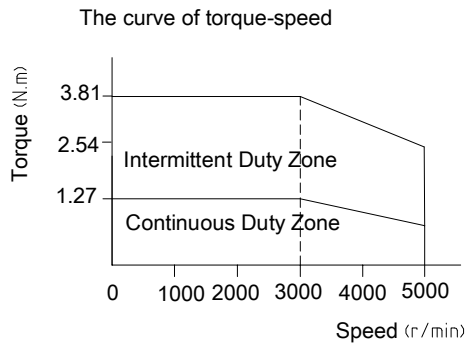

Leadshine Technology Co.,Ltd

ELM1H-0400MA60F

60mm,high inertia,400w servo motor
23bit magnetic encoder, no brake